

# Operating Instruction Manual



---

Thank you for purchasing our product

Please read this operation instruction manual carefully before use, and follow the manual to install and use it.

Additionally, please pay attention to the security precautions.

## Content

<b>1、 Product introduction</b>	<b>2</b>
<b>2、 Features</b>	<b>3</b>
<b>3、 Description of the indoor &amp; outdoor unit</b>	<b>4</b>
<b>4、 Appearance of product parts</b>	<b>5</b>
<b>5、 Installation</b>	<b>6-7</b>
<b>6、 Connection(model A)</b>	<b>8</b>
<b>7、 Operation</b>	<b>9</b>
<b>8、 Specifications</b>	<b>10</b>
<b>9、 Attention</b>	<b>11</b>
<b>10、 After-sales service</b>	<b>12</b>

## 1、 Product introduction

Thank you for purchasing our product.

The four-line we produced is a luxury household security product for one-family buildings or upscale villas. It adopts advanced technology and the latest computer chips which highly improves the stability and durability of the system.

The product has: hands-free monitor and two-way intercom, high-definition visibility, lock control, infrared night-vision outdoor station, adjustable intercom volume and screen color, pictures or videos can be read or stored when the memory card is inserted and so on.

This product can meet different clients' requirements, such as one-to-one, one-to-two, one-to-three, one-to-four, two-to-one, two-to-two, two-to-three, two-to-four.

This product has fashionable and beautiful appearance, and it adopts the design of ultrathin wall mounting type which makes this product light and convenient. This special design helps it make full use of smaller space. Apart from those, it can also be regarded as a peculiar decoration to beautify your house and brings about comfortable life.

Functions of this product are reliable and convenient to use and install. Hence, this product is the ideal theft prevention equipment.

It is widely used in single-family houses, villas, office and so on, meanwhile it also the ideal present giving to friends or relatives.

In order to create more comfortable and securer living environment, please choose our visible intercom doorbell product to ensure your safety and comfort.

## **2、 Features**

This system can be used in apartments, villas, hotels and offices etc.

For better taking advantage of the prior functions please carefully read our instruction for correct installation and operation.

- 1、 Aluminum alloy panel of indoor unit, fashionable and luxury.
- 2、 Water & oxidation-proof, durable aluminum alloy made outdoor station
- 3、 7" color TFT LCD. No radiation, low power consumption and high definition
- 4、 The camera could be high definition
- 5、 Handfree intercom
- 6、 Electric lock-control function
- 7、 Monitor the view out of the door.
- 8、 16kinds of rings for your options.
- 9、 Volume, brightness & contrast adjustable.
- 10、 With adapter and cable, users could install it by them-self
- 11、 With micro-processing technology, auto-remote control, excellent performance and high reliability

### 3、 Description of the indoor & outdoor unit

#### A、 Indoor

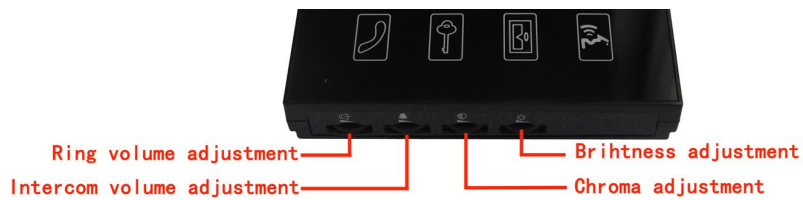
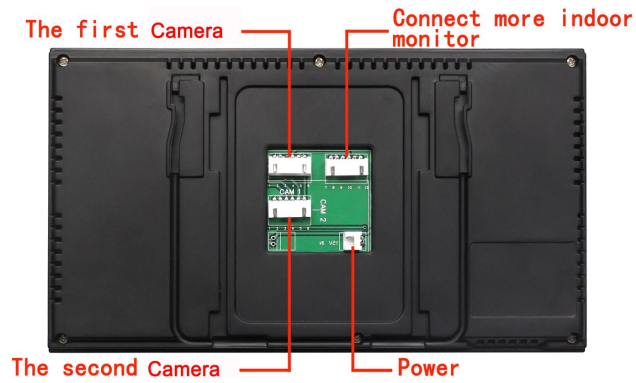
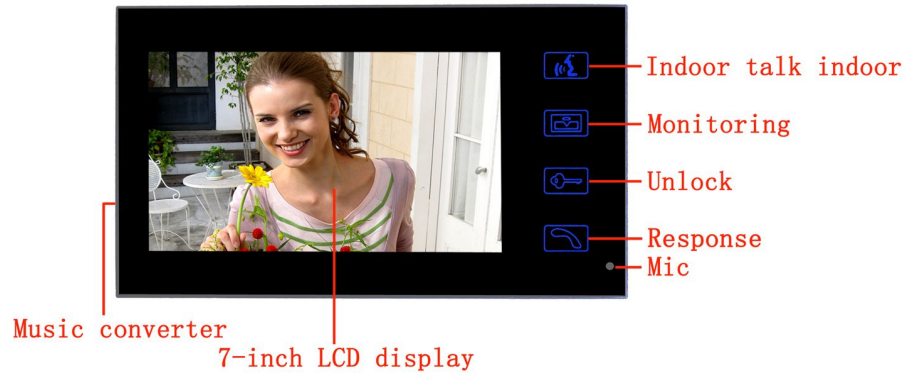

#### B、 Outdoor



## 4、Appearance of product & parts

① Check the things in the pocket



Indoor unit



Outdoor station

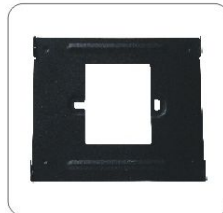

Mounting plate

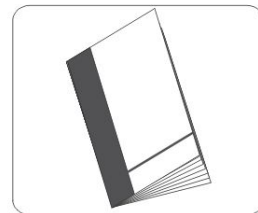

Operation instruction

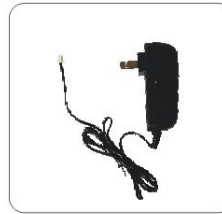

Adapter



Cable

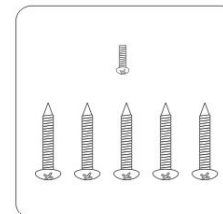

Screws and others

## 5、 Installation

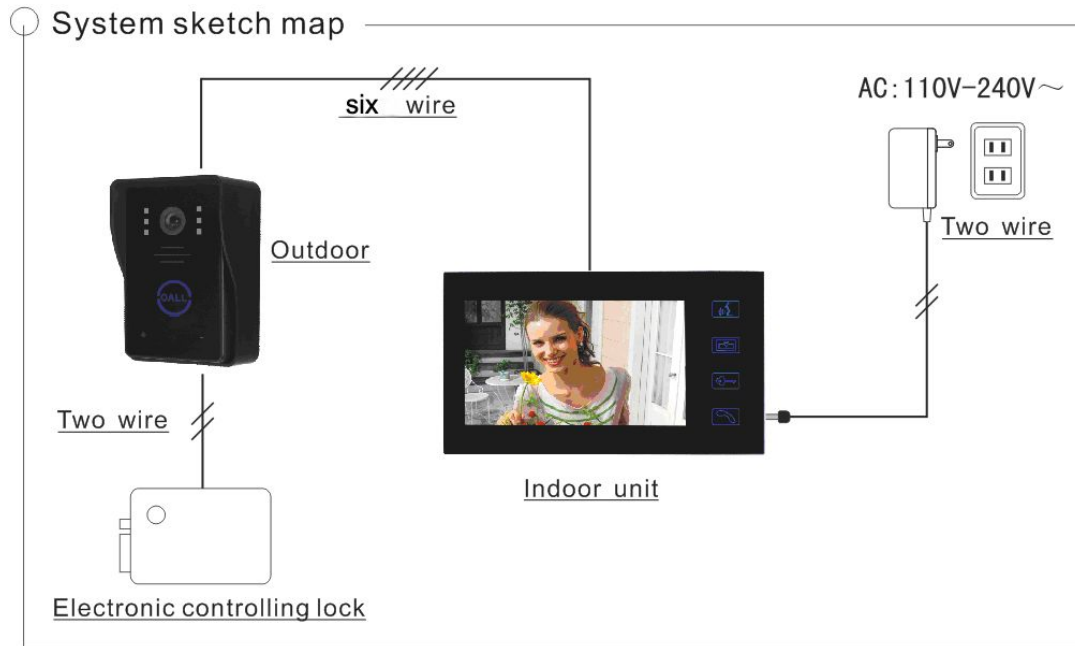

The installation of indoor unit



The perfect installation height of indoor unit is that the center of the surveillance screen should be 145cm~160cm above earth.

Firstly use two screws to fix the mounting plat on the wall, and then hang up the indoor unit (see the picture above)

(This parameter is only for reference)

## 5、 Installation

### The installation of station

Effective range

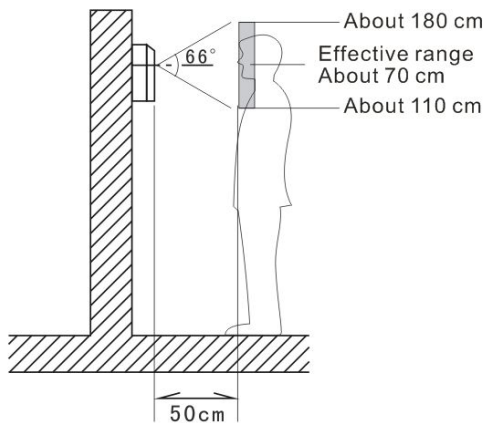

Effective range for up and down

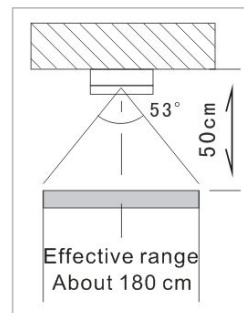

Effective range for left and right



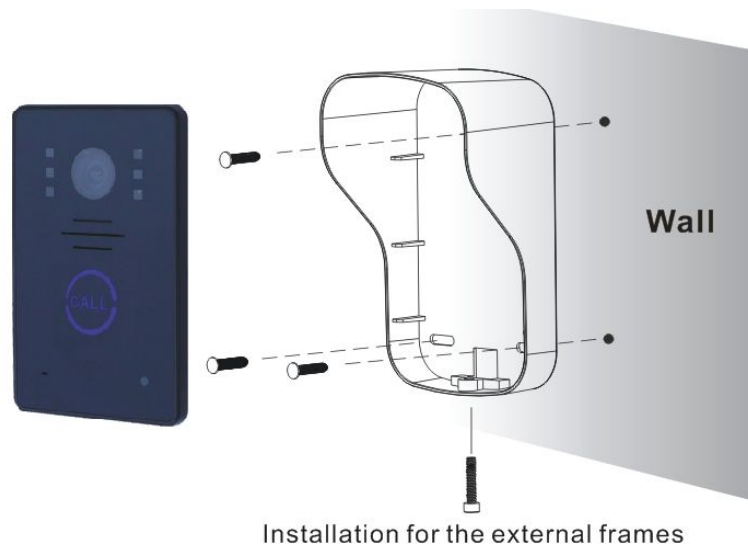

- ※ Attention items  
Avoid installing this camera with directly exposure to sunlight. At night, when the visitors' back is shone by the streetlight or luminance things, you should install a light to enhance the imaging effects

## 6、 Connection

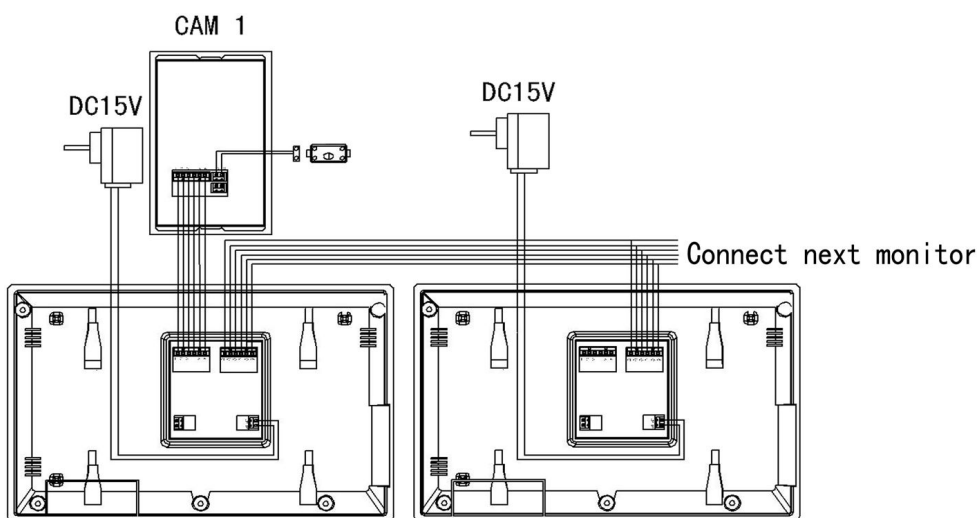

**One to one/One to two/One to three/One to more**

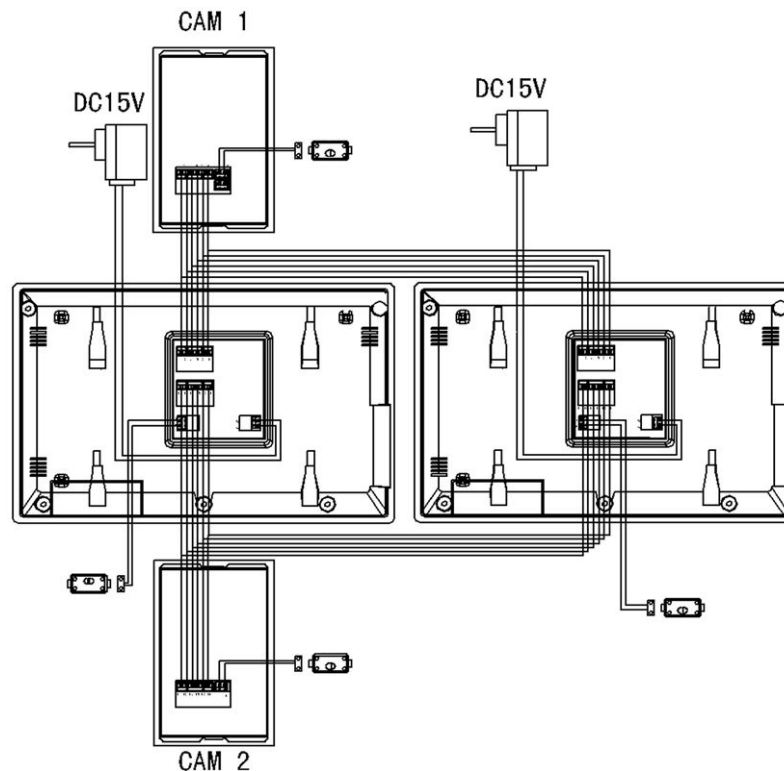

**Two to one/Two to two/Two to three/Tow to more**

**Page 8**

## **7、 Operation**

### **Visitors Calls**

The visitor presses the CALL button on the outdoor door station, all installed monitors will ring and the visitor will be seen, the host can talk to the visitor by pressing the TALK button once.

Press TALK again to cancel.

### **Answering the visitors call from installed monitor**

Press INTERCOM once on any of the installed monitors and a 2 way conversations can be started between the monitor and door station.

### **Viewing the outside (40 seconds duration)**

Pressing MOINTOR from any installed monitor will switch on the outdoor door station and view of the outside will be seen on the screen.

Pressing MONITOR again will cancel the outdoor monitoring.

### **Unlock function**

Press the UNLOCK button at any time to open the electric lock.

### **Fine tuning the monitor:**

You can adjust the Brightness, Contrast and Volume to achieve the best results.

### **Intercom calls**

Under the standby state, press the INDOOR INTERCOM of one monitor first, the other monitor will ring, press the INTERCOM of the other monitor, and press INTERCOM on the other monitor to start an internal intercom conversation.

Press INTERCOM again to cancel the internal intercom conversation.

## **8、 Specifications**

Screen size: 7" TFT (16:9 Display)
Resolution: 960xRGBx480
Dimensions of monitors: 235.5mm (W) x 165.5mm (H)
Power input: AC 100V-240V 50 Hz/60 Hz
Power output: DC15V
Current output: 1200MA
Call duration time: 120 Seconds
Monitor duration time: 40 Seconds

Distance with supplied cable (6x0.65mm <sup>2</sup> ): 50 metres
Maximum Transmitting distance: 200 metres
Power consumption: Static state <0.5W, calling <10W
Camera viewing angle: 92 degrees (adjustable)
Working temperature: 10 degrees Celsius ~ +50 degrees Celsius
Comparative temperature: 10% 90% (KH)
Indoor size: 228mm*130mm*25mm
Outdoor size: 112mm*66mm*168mm

## 9、Attention

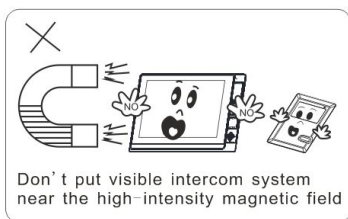

1

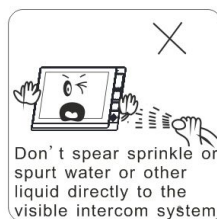

2

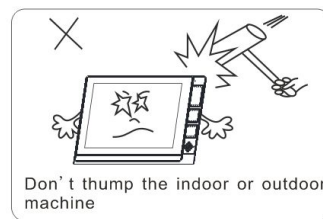

3

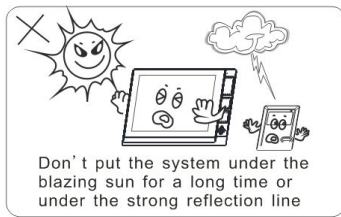

4

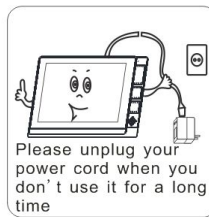

5

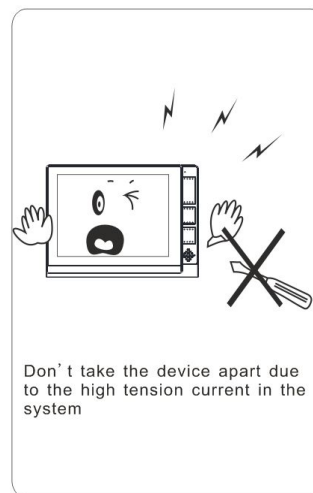

8

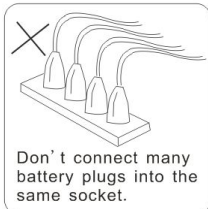

6

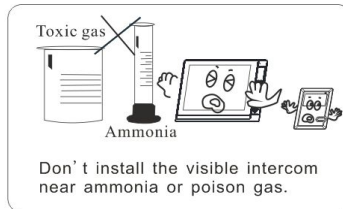

7

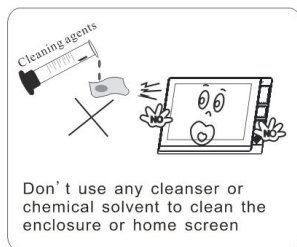

9

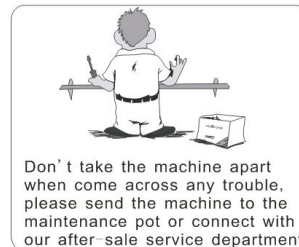

10

## 10、 After-sales service

1. From the day you purchase the machine, our company will provide free maintenance for the normal breakdown of the product within the warranty period.
2. Products of our company could enjoy one year warranty and can be changed within one month, if there are any quality problems.



Shenzhen SUNSKY Technology Limited

3. Within the warranty period, if the machine is man-made dismantled or damaged despite of the requirements for using, maintaining, taking care of in the product instruction, we will ask for the cost fee for the components.
4. Warranty place: the defective products will be sent back to our company by the distributors. The Shenzhen factory of our company will arrange maintenance work.
5. Warranty area: China

-----  
Users' Warranty Card

Name		Purchase Date	
Contact Number		Postal code	
Address			
Product type			
Distributors' phone		Distributors' seal	

Note: blanks above should be sincerely filled by the final users and distributors, and the users could enjoy after-sale service relying on the card.